

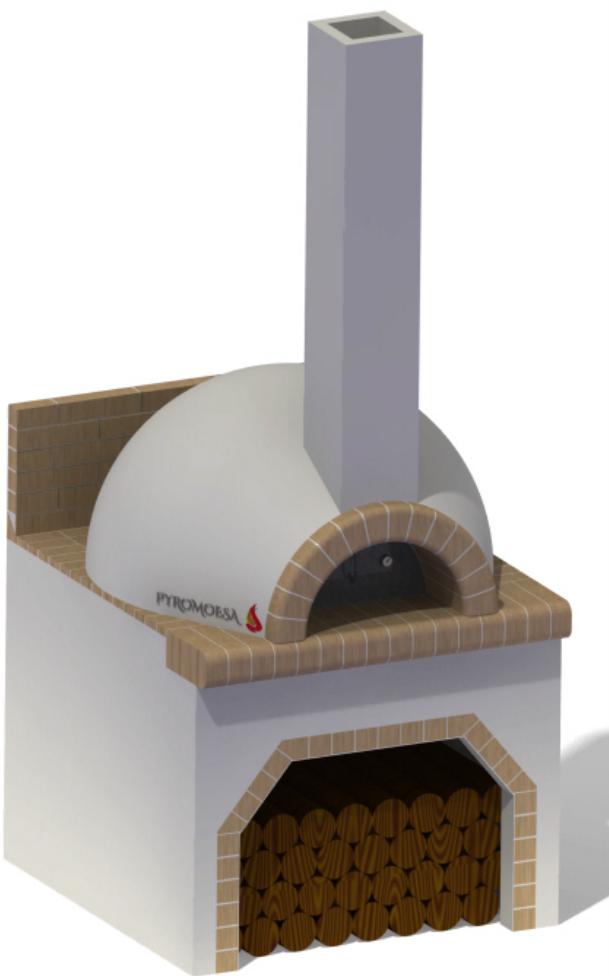

PYROMOESA

Ghid montaj cuptor



Cuptor- 80cm interior
Blat- 100x110cm

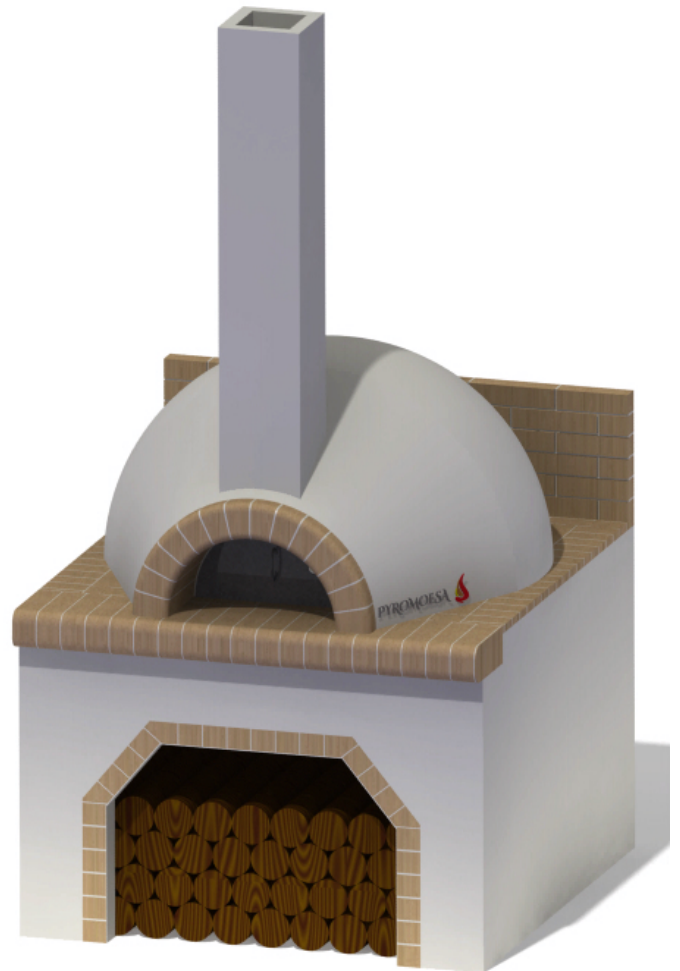

Cuptor- 100cm interior
Blat- 120x130cm

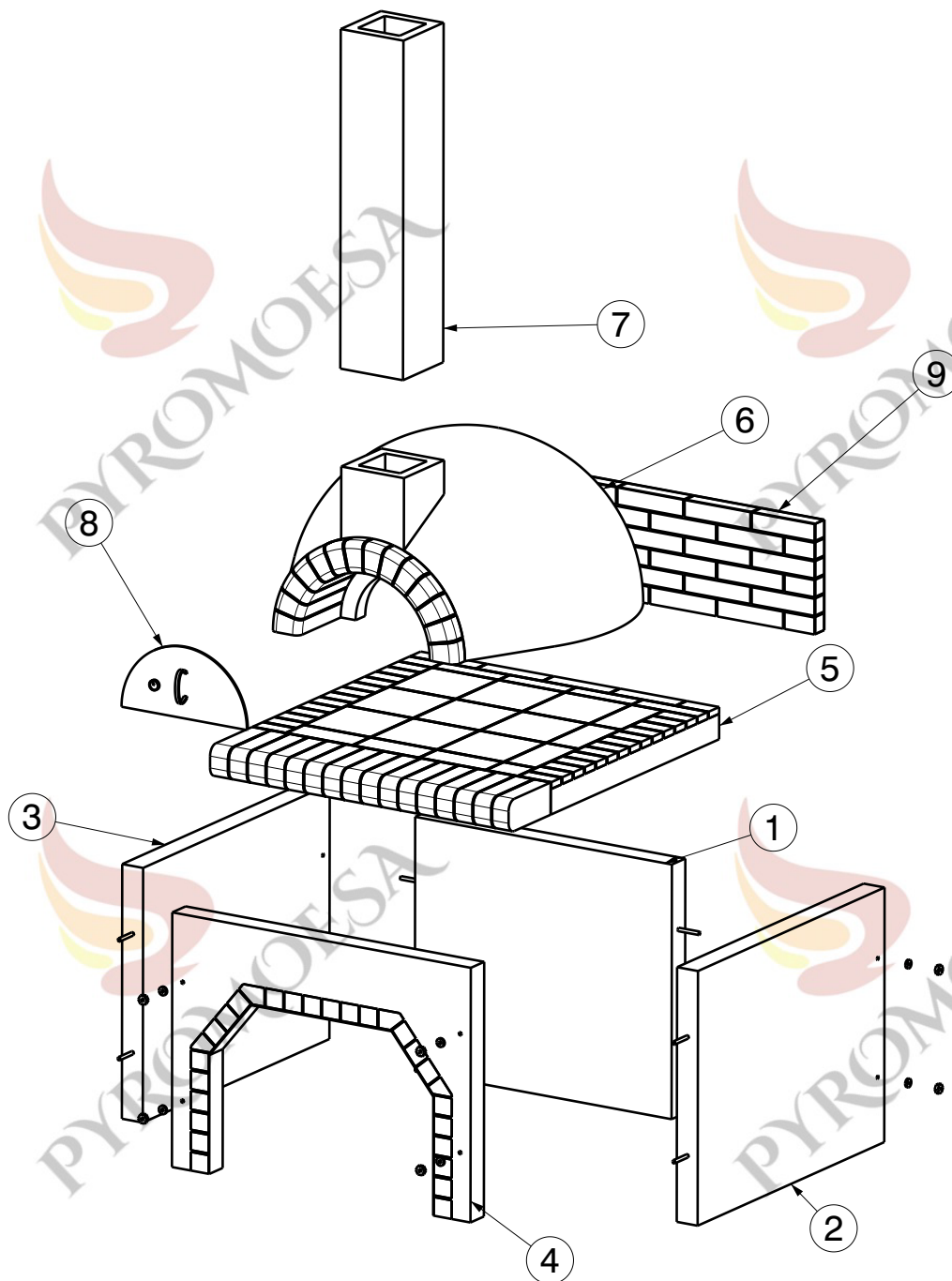

Nota:

Dimensiunile contin tolerante de 0.5cm
La asamblarea finala trebuie luat in
calcul si grosimea stratului de adeziv

Nr. Crt.	Denumire	Dimensiuni [cm]	
		L	l
1	Picior spate	85 105	75
2	Picior dreapta	97.5 117.5	75
3	Picior stanga	97.5 117.5	75
4	Picior fata	100 120	75
5	Blat	110 130	100 120
6	Cuptor	Ø80 interior Ø100 interior	
7	Horn	21x21 exterior	
8	Usa cuptor	R27	
8	Paravan	100 120	37

Pas 1

Adeziv flexibil

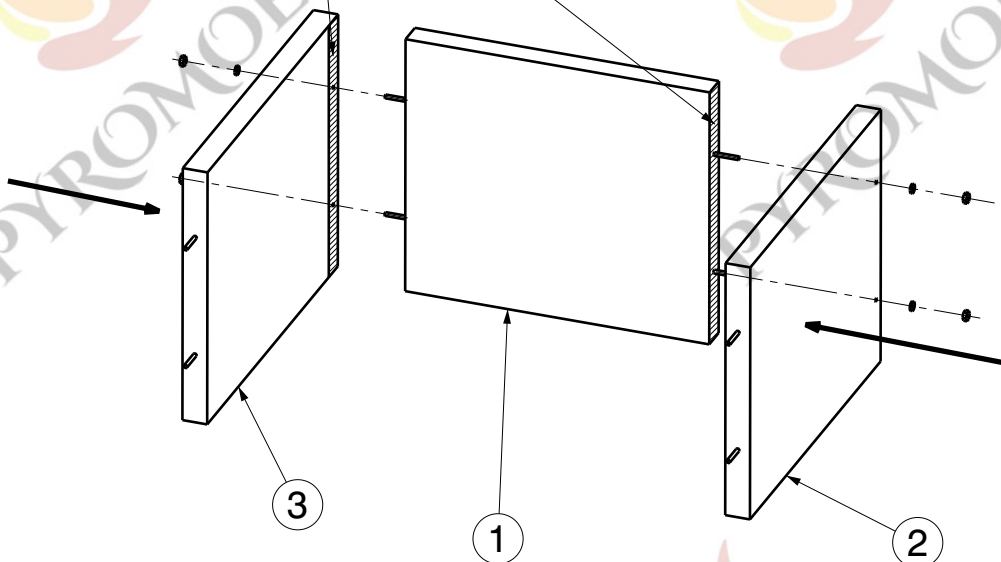

Pas 2

Adeziv flexibil

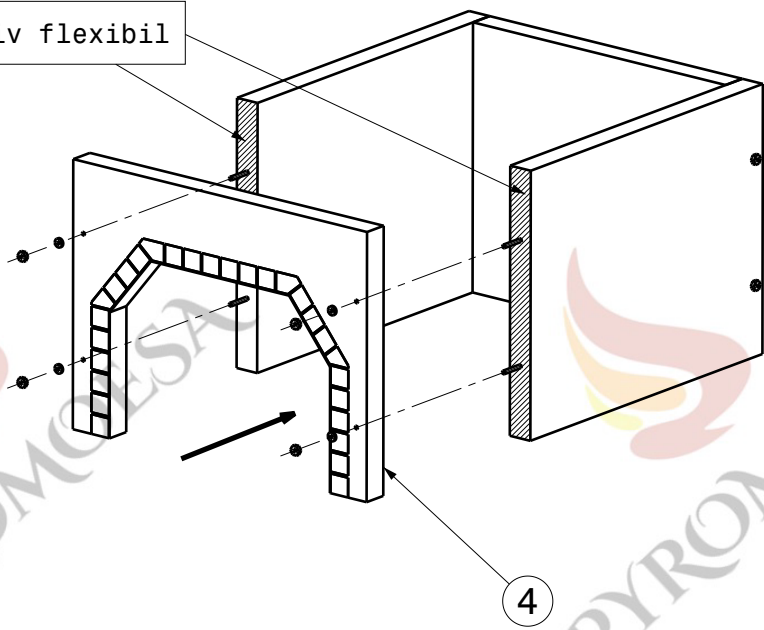

Pas 3

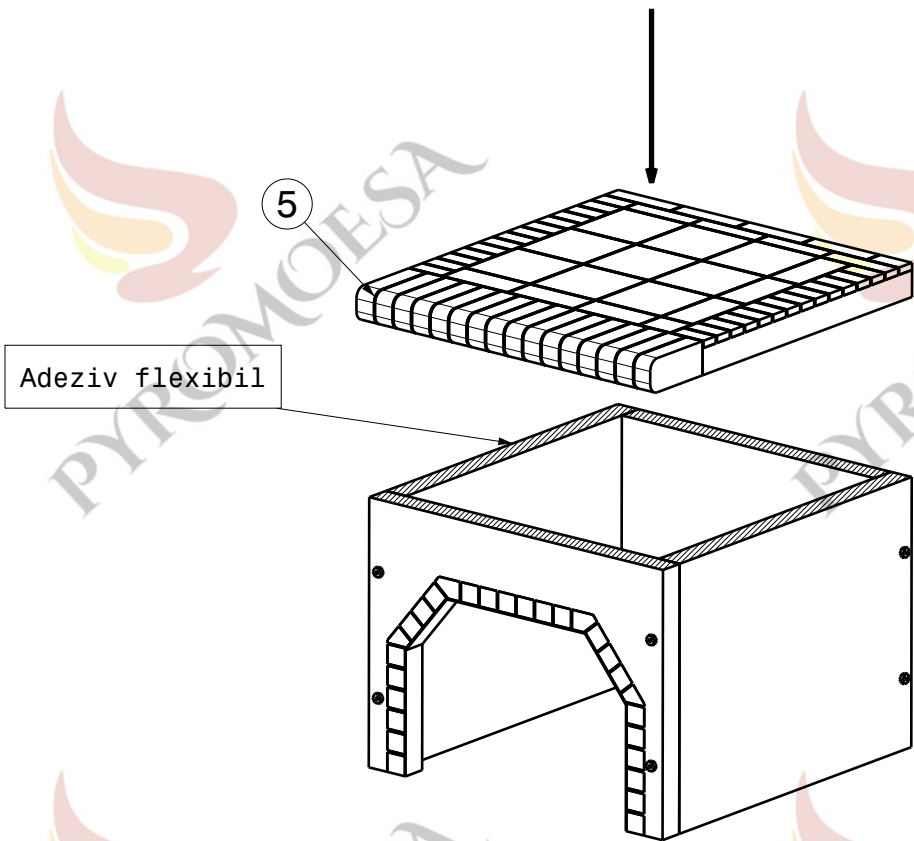

Pas 4

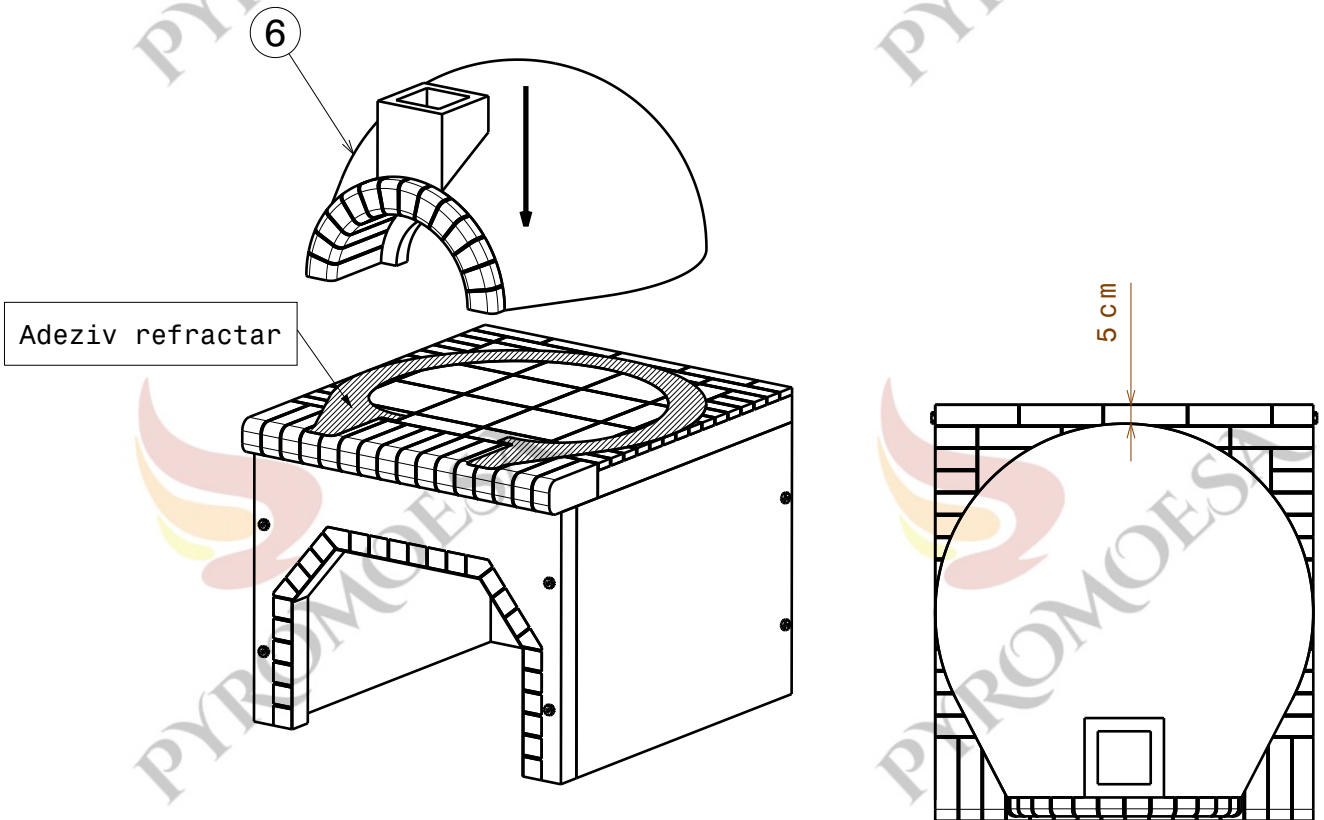

Pas 5

